



**444 0 942**

[www.gmasansor.com.tr](http://www.gmasansor.com.tr)



**Değerli Müşterimiz,**

30 yılı aşan meslek hayatımızda işimizle alakalı tek amacımız var; **GM**'nin marka değerini yükseltmek. Ticari gelir elbette ki bir işletmenin var olabilmesi için temel koşuldur, ama **GÜVEN** bizim için firmamızın en büyük değeridir.

Konu asansör olduğunda "**GM Asansör'ün görüşünü de alalım**" dedirtebiliyorsak biz hedefimize ulaşmış sayılırız. Kadrolarımız da ehliyetli ve işini seven insanları istihdam ediyoruz ve onlara yalnızca en iyi malzemeyi, en yetkin işçilikle, kuralına ve standarta uygun, **GÜVENLİ** asansörü oluşturuyoruz.

İşimize duyduğumuz saygıyı ve kalitemizi gösteren kriter, yaptığımız asansörlerimizdir.

**Saygılarımızla...**  
**GM Asansör**

[www.gmasansor.com.tr](http://www.gmasansor.com.tr)

**444 0 942**

# LINE SERİSİ MRL

## MAKİNE DAİRESİZ

Makine dairesiz asansör sistemlerinde, kuyu üzerinde makine dairesi alanı kullanılmadığından, bu alan proje de esneklik sağlar. Dişlisiz makine kullanılır ve dişlisiz makine diğer asansör makinelerine oranla çok daha verimlidir. Ayrıca enerji tüketiminde geleneksel asansör motorlarına göre %40 daha az enerji tüketmektedir.

### Makine dairesiz sistemlerin avantajları:

- Makine dairesiz tasarım ile bina hacminde tasarruf,
- Üstün kontrol teknikleri ile eşsiz duruş hassasiyeti,
- Her çeşit binaya kolay uygulama,
- Üstün performansı ile sessiz ve konforlu seyir,
- Daha az kalkış akımı, daha az enerji kullanımı,
- Hızlı ve etkin montaj,
- Optimum performans.

## GENEL ÖZELLİKLER

KAPASİTE	320 Kg	450 Kg	630 Kg	800 Kg
	4 Kişilik	6 Kişilik	8 Kişilik	10 Kişilik
Hız	1m/sn.			
Maksimum Seyir	30 mt.			
Maksimum Kat Sayısı	10 Durak			
Kabin Girişleri	1-Ön 2-Ön ve Arka			
Motor	Dişlisiz			
Kumanda Sistemi	Geta MOT Hazır Tesiat			
Kapı Tipi	Otomatik			
Kapı Ölçüsü	700/800/900 mm (Satine Paslanmaz)			
Kapı Yüksekliği	2000 mm / 2100 mm			
Kabin	Satine Paslanmaz			
Kabin İçi Aydınlatma	Endirekt Aydınlatma			
Taban	Spek, Antibakteriyel			
Kabin İç Yüksekliği	2150 mm			
Butonyer	Dotmatrix Gösterge (Tam Boy Butonyer)			
Sisteme Dahil Olanlar	Kuyu Dibi Merdiveni / Separatör / Kuyu İçi Aydınlatması / Enerji Besleme Panosu			

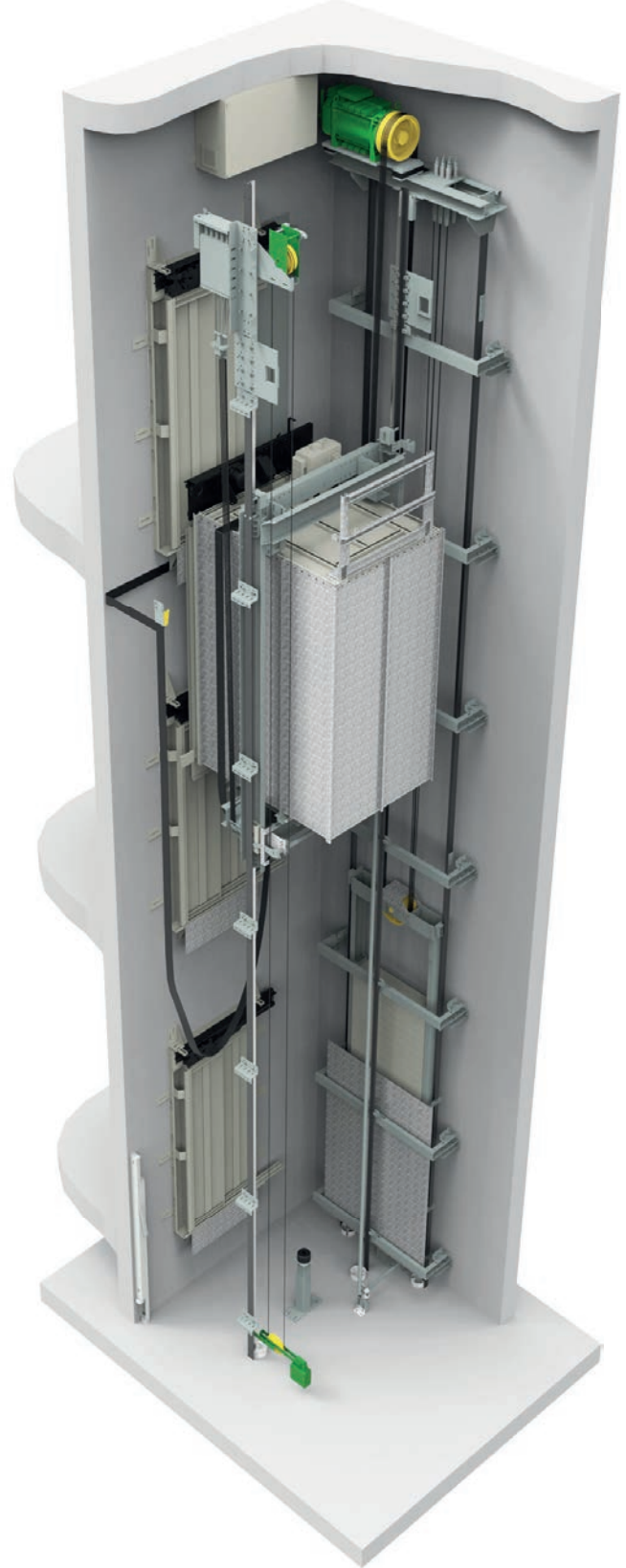

# NORM SERİSİ MRL

MAKİNE DAİRESİZ

Makine dairesiz asansör sistemlerinde, kuyu üzerinde makine dairesi alanı kullanılmadığından, bu alan proje de esneklik sağlar. Dişlisiz makine kullanılır ve dişlisiz makine diğer asansör makinelerine oranla çok daha verimlidir. Ayrıca enerji tüketiminde geleneksel asansör motorlarına göre %40 daha az enerji tüketmektedir.

## Makine dairesiz sistemlerin avantajları:

- Makine dairesiz tasarım ile bina hacminde tasarruf,
- Üstün kontrol teknikleri ile eşsiz duruş hassasiyeti,
- Her çeşit binaya kolay uygulama,
- Üstün performansı ile sessiz ve konforlu seyir,
- Daha az kalkış akımı, daha az enerji kullanımı,
- Hızlı ve etkin montaj,
- Optimum performans.

## GENEL ÖZELLİKLER

KAPASİTE	320 Kg	450 Kg	630 Kg	800 Kg	1000 Kg
	4 Kişilik	6 Kişilik	8 Kişilik	10 Kişilik	ve Üzeri
Hız	1m/sn., 1,6 m/sn., 2 m/sn., 2,5 m/sn.				
Maksimum Seyir	70 mt.				
Maksimum Kat Sayısı	25 Durak				
Kabin Girişleri	1-Ön 2-Ön ve Arka				
Motor	Dişlisiz				
Kumanda Sistemi	Geta MOT Hazır Tesiat				
Kapı Tipi	Otomatik Kapı (Sağ/Sol/Merkez)				
Kapı Ölçüsü	700/800/900 mm üstü (Satine Paslanmaz)				
Kapı Yüksekliği	2000 mm / 2100 mm				
Kabin	Satine Paslanmaz				
Kabin İçi Aydınlatma	Endirekt Aydınlatma				
Taban	Spek, Antibakteriyel				
Kabin İç Yüksekliği	2300 mm				
Butonyer	Dotmatrix Gösterge (Tam Boy Butonyer)				
Sisteme Dahil Olanlar	Kuyu Dimi Merdiveni / Separatör / Kuyu İçi Aydınlatması / Enerji Besleme Panosu				
Opsiyonlar	3 Panel / 4 Panel But-San Butonyer Ses Anonsu TFT Gösterge Kapı Üstü Gösterge Nokta veya Dekoratif Paslanmaz				

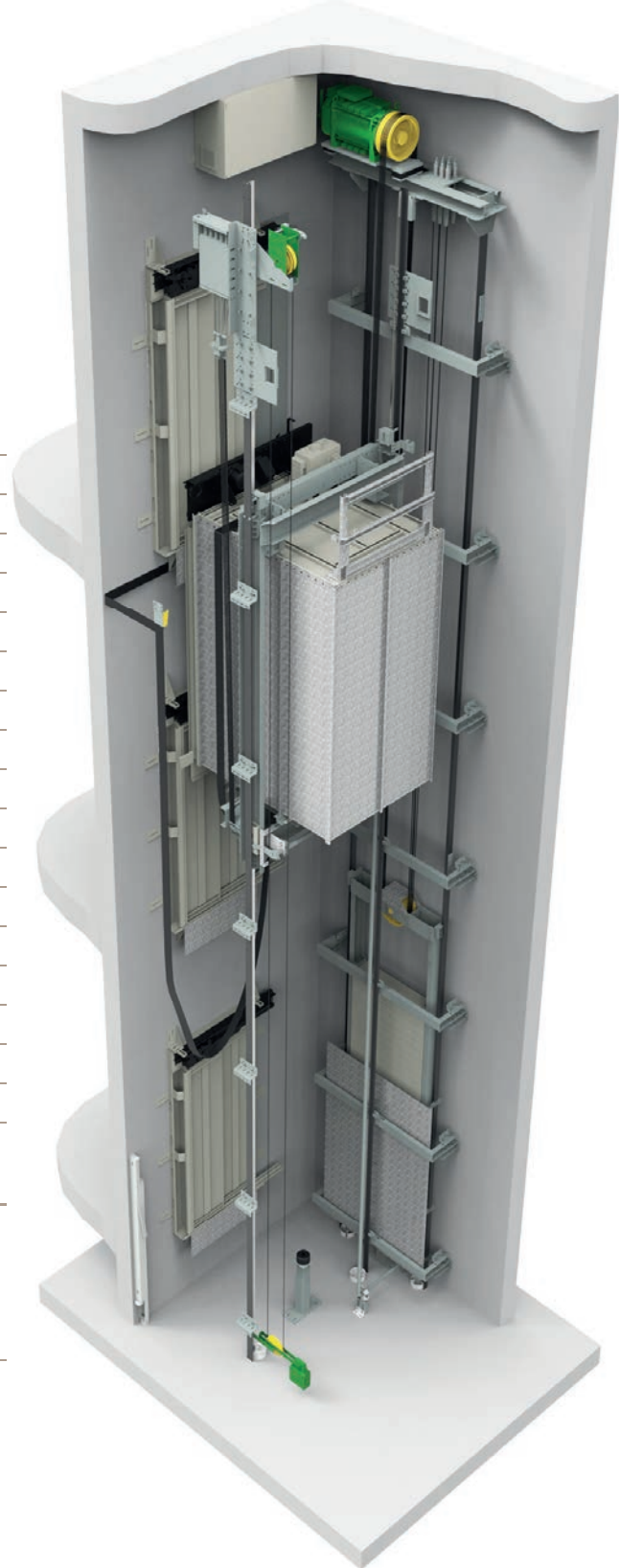

# FITLIFT

## MAKİNE DAİRESİZ

Makine dairesiz asansör sistemlerinde, kuyu üzerinde makine dairesi alanı kullanılmadığından, bu alan proje de esneklik sağlar. Dişlisiz makine kullanılır ve dişlisiz makine diğer asansör makinelerine oranla çok daha verimlidir. Ayrıca enerji tüketiminde geleneksel asansör motorlarına göre %40 daha az enerji tüketmektedir.

### Makine dairesiz sistemlerin avantajları:

- Asansör kuyusuna ihtiyaç duymaz,
- Düşük Kuyu Dibi İhtiyacı: Minimum 200 mm
- Düşük Son Kat Yüksekliği: Minimum 2650 mm
- Makine dairesine ihtiyaç yoktur,
- 630 kg. kapasiteye kadar uygulanabilme,
- EN 81-21 STANDART'ı tip onay belgesi,
- Otomatik kata getirme ve acil kurtarma sistemi,
- 3 yönden giriş imkanı,
- Sessiz çalışma, 45-50 db.,
- Özel tasarım çelik kuyu.

## GENEL ÖZELLİKLER

KAPASİTE	320 Kg	450 Kg	630 Kg
	4 Kişilik	6 Kişilik	8 Kişilik
Hız	1m/sn.		
Maksimum Seyir	∞		
Maksimum Kat Sayısı	∞		
Kabin Girişleri	3 Giriş İmkani		
Motor	TORİN / SASSİ		
Pano	Özel		
Kapı Tipi	Otomatik Kapı (Sağ/Sol/Merkez)		
Kapı Ölçüsü	700/800/900 mm (Satine Paslanmaz)		
Kuyu Ölçüleri	K.D.: 200 mm (min.) S.K.:2700 mm (min.)		
Kapı Yüksekliği	2000 mm		
Kabin	Satine Paslanmaz		
Kabin İçi Aydınlatma	EnDirekt Aydınlatma		
Taban	PVC		
Kabin İç Yüksekliği	2150 mm (Son Kat Ölçüsüne Bağlı)		
Butonyer	Dotmatix Gösterge (Tam Boy Butonyer)		
Sisteme Dahil Olanlar	Separatör/Kuyu İçi Aydınlatması /Enerji Besleme Panosu		
Opsiyonlar	3 Panel / 4 Panel Ses Anonsu TFT Gösterge, Kapı Üstü Gösterge Nokta veya Dekoratif Paslanmaz		

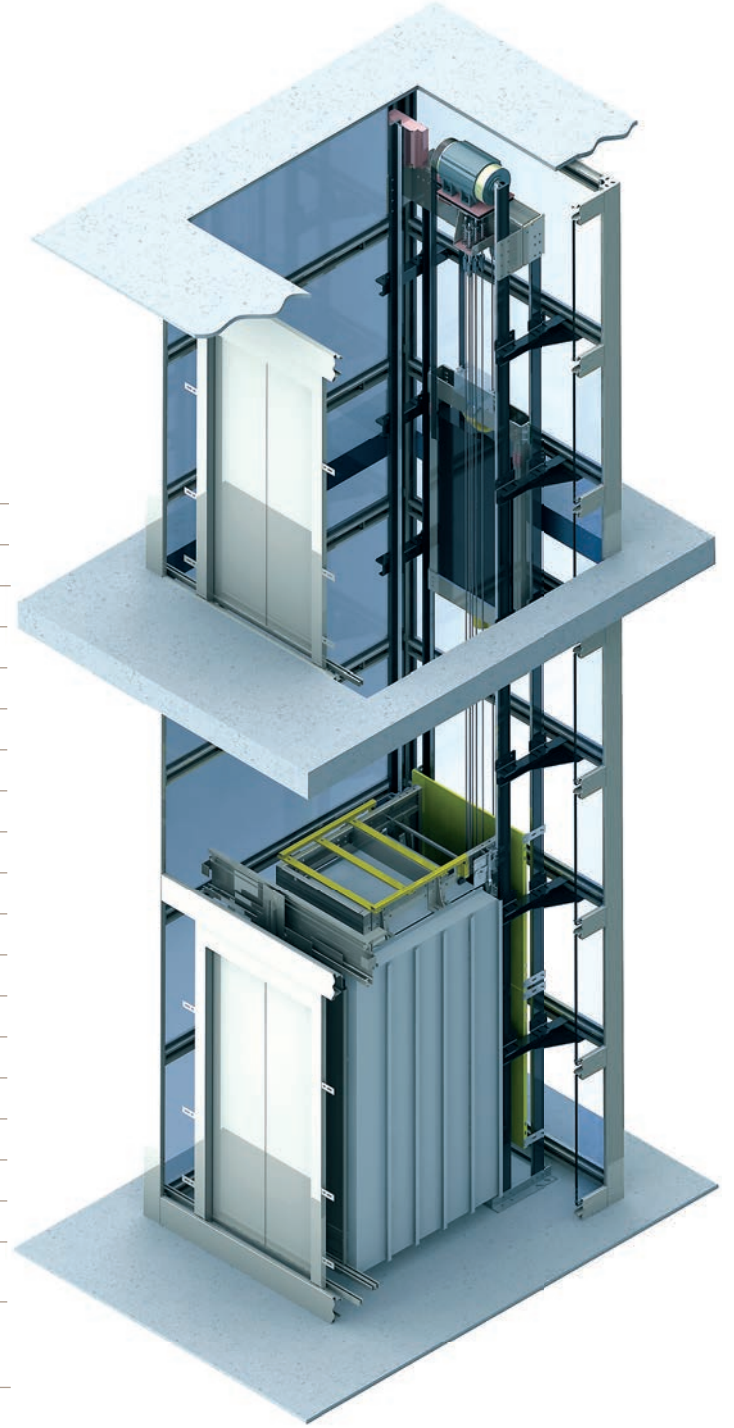

# YÜK ASANSÖRÜ

Fabrika, depo ya da otoparklarda kullanılmak üzere tesis edilen asansörlerdir. Bu asansörler ağır ortam şartlarında başarıyla çalışır. Yalnızca yük taşımak amacıyla yapılan yük asansörlerinin kabin veya platform boyutları ve motor güçleri, taşınması gereken en büyük yük miktarına göre belirlenir. Tesis edildiği binanın en zor şartlarına göre tasarlanan yük asansörlerimiz, 500 kg'dan 10.000 kg'a kadar çeşitli kapasitelere sahiptir. Elektrikli veya hidrolik tahrikli olarak yapılmaktadır.

**Hidrolik Tahrikli 2/ Askı**  
Hydraulic Drive 2/1

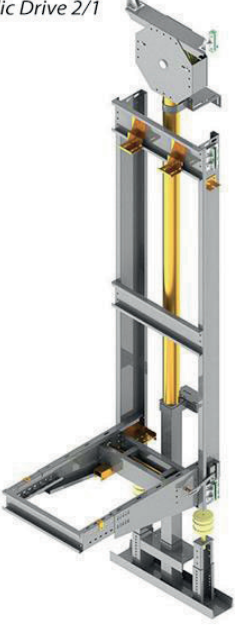

# ARAÇ ASANSÖRÜ

## Hidrolik Oto Asansörü

İki veya daha fazla kat arasında, çok az kuyu dibine ihtiyaç duyacak şekilde, araç taşınabilmesi için tasarlanmıştır. Bu şekilde rampa yapılmayacak alanlar ve binalar için en uygun çözümü oluşturur. Bu sistem makine direktifi 98/37/AT ve 2006/42 EC standartlarına uygun üretilmiştir. Bu sistemlerin avantaj 12 m'ye kadar dikey taşıma kapasitesine sahip olup kolay kurulum ve kolay bakımının olmasıdır.

### Özellik ve Avantajlar

- Min. 400 mm dibi gerekir,
- Piston montajı için kuyunun tek tarafında 300 mm yeterli olacaktır,
- Muadillerinden daha düşük maliyetlidir,
- AR-GE departmanında ki mühendislerin çalışmaları sonucu dizayn edilerek piyasaya sunulmuştur,
- Kolay ve hızlı montaj,
- Ürün tip uygunluk ve CE sertifikaları mevcuttur,
- Teknik destek ve garanti.

	2200	3000
SEYİR	2000 mm ile 12.000 mm	2000 mm ile 10.000 mm
MAKS. KAPASİTE	2200 kg	3000 kg
MİN. KUYU DİBİ	400 mm	500 mm
MAKS. PLATFORM GENİŞLİĞİ (net)	2440x5500 mm	

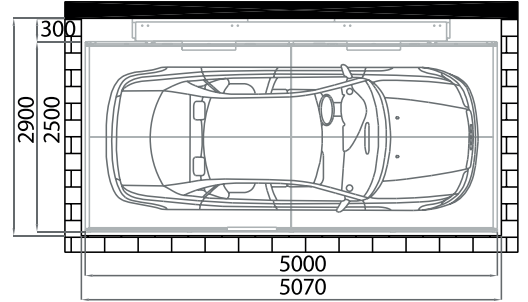
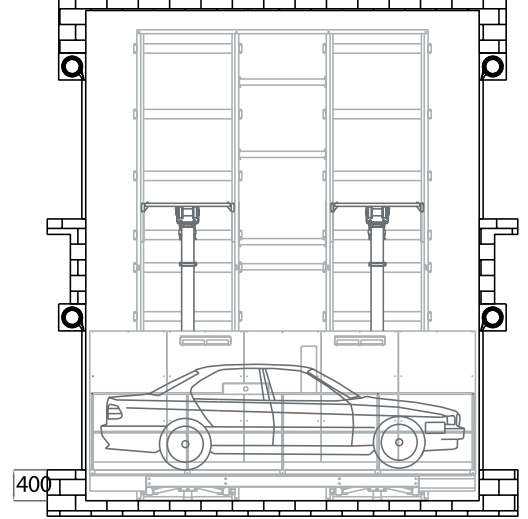

# YATAY ASANSÖR

EĞİMLİ ALANLAR İÇİN



Görseller, Bolu Grand Kartal Otele firmamızca yapılan yatay asansöre aittir.

**Eđimi fazla olan,** asansör kurulumu yapılamayan yerler için ideal çözümdür. Yürüyen merdivenlerin aksine kabin içinde kullanıcıların hava şartlarından etkilenmeden konforlu ve güvenli yolculuk yapmasını sağlar.

- Kot farkı olan arazilerde, konforlu ulaşım için ideal bir çözümdür.
- Panoramik kabini ile manzaralı bir seyir sağlar.
- Açık hava şartlarına karşı korumalıdır.
- Engelli yönetmenliğine uygundur.
- Avrupa Birliği standartlarını sağlar.
- Yüksek trafik durumunda dahi tam performans sağlar.



# ENGELLİ PLATFORMU

HYD MAK -ALANI VERİMLİ KULLANIR

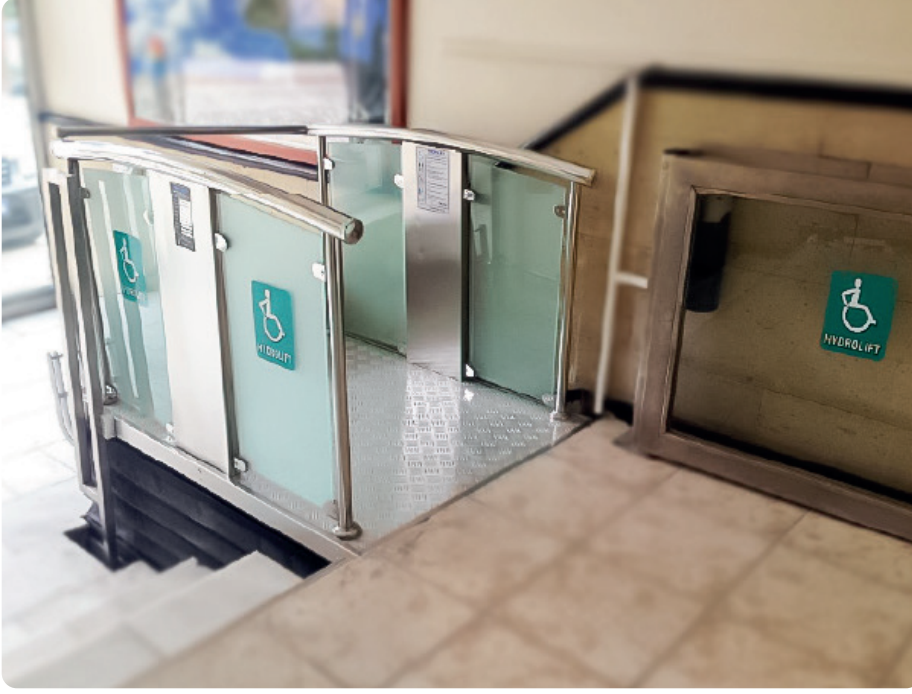

**Makaslı Engelli Platformu** okul, camii, otel, rehabilitasyon merkezleri, mağazalar ve kurulum alanı dar olan makine ve kumanda sistemleri kompakt, iç ve dış mekanlarda güvenle kullanabileceğiniz düşük maliyetli şık tasarımı ile yapıya estetik bir görünüm kazandıran HYD-MAK makaslı tip engelli platformu, AISI 304 kalite paslanmaz krom kaplamasıyla nem, yağmur, kar ve rutubetten etkilenmez. Hidrolik olması sebebiyle sessiz ve uzun ömürlüdür. Titreşim emici komponentleri ve geliştirilmiş bronz yatakları yüksek performans sunar.

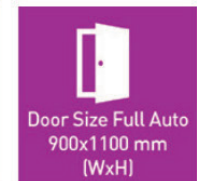
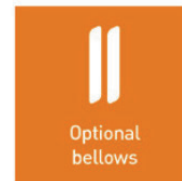
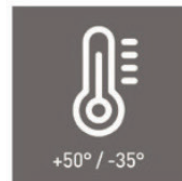
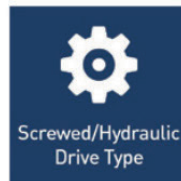
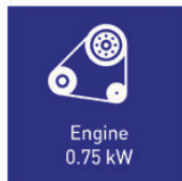
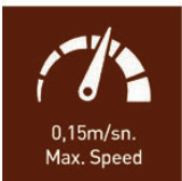
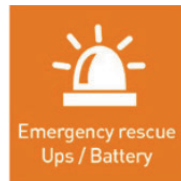
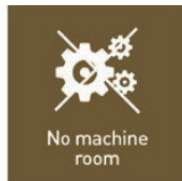
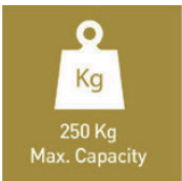
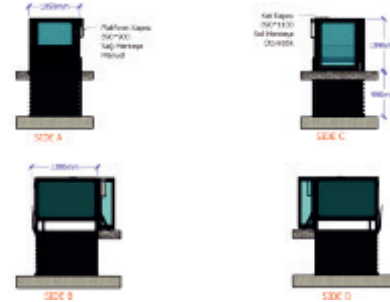
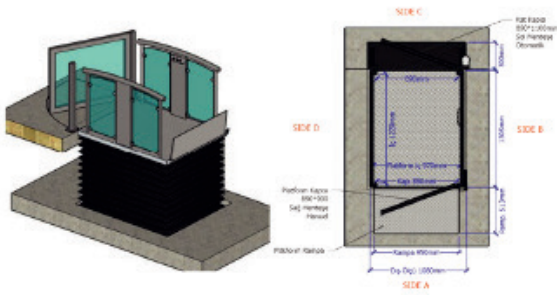

# ENGELLİ PLATFORMU

Sonsuz Vida Milli Tahrik - KAPALI



**Asansör** kuyusu ve ruhsat gerektirmeyen, tekerlekli sandalye ile de kullanabileceğiniz **HYD-VK** Avrupa standartlarına tam olarak uygun olup **Udem Adriatic** tarafından onaylanmıştır. İç mekan veya dış mekanlarda güvenle kullanılır. Kullanım kolaylığı, pratik montajı ve asgari inşaat masrafı ile yapılarınız için uygundur. İthal kilit sistemi, geliştirilmiş kovan sistemi, bronzdan imal edilmiş somun, honlanmış özel sonsuz vida ile sessiz ve konforlu olan seyahati düşük bakım maliyeti ile sunar. 6 farklı standart ölçü ile üretildiği gibi istenildiğinde yapılarınızın fiziki durumlarına uygun özel ölçü ve özelliklerde üretilmektedir. Küçük bir ev aleti kadar enerji tüketen ürünlerimiz invertör sürüş sistemi ile yumuşak kalkış ve duruş konforu sunarken, evsel enerji tüketiminizi de düşürür.

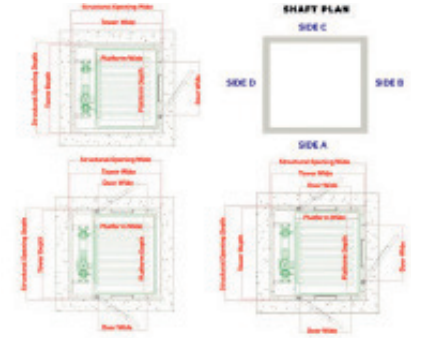
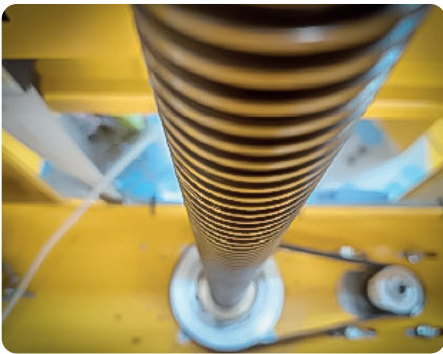
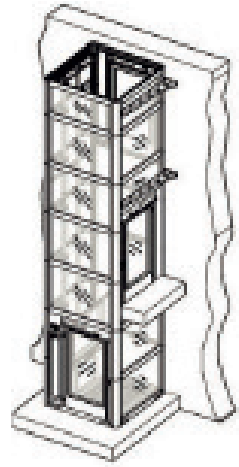
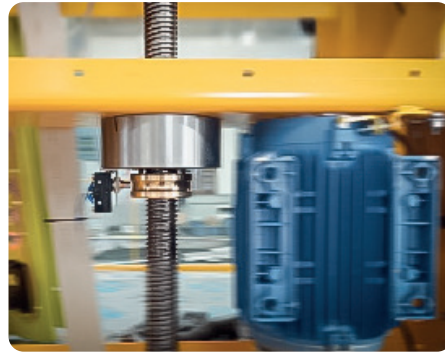

400 Kg Max. Capacity	Maximum Number of stops 5	No machine room	Emergency rescue Ups / Battery	Do not require a pit	1300x1400 mm (W x D) Platform size	1600x1600 mm (W x D) Tower dimensions	Door Size Full Auto 900x2050 mm (WxH)
0,15m/sn. Max. Speed	110 / 230 V 50-60 Hz	Engine 2,2 kW	Screwed drive type	30.000 mm Max. Travel	Soundless	3 Language Voice Announcements	



444 0 942

www.gmasansor.com.tr

# KURUMSAL

KABİN



- Dikey Satine Paslanmaz
- Ara Çıtalar Ayna Paslanmaz
- Tam Boy Ayna
- Spek, Antibakteriyel Taban
- Tam Boy Butonyer



- Satine Paslanmaz Duvarlar
- Mat Ayna Ara Çıtalar
- 600 veya 800 mm Ayna Geniřlięi
- Torin Model Dekoratif Tavan
- LED Armatür Aydınlatma
- Spek Anti Bakteriyel Taban

# BUTONYERLER

- Dotmatrix gösterge
- Kolay ve hızlı montaj
- Görme engelliler için kabarma figürlü uygun tasarım butonlar
- 304L kalite satine paslanmaz çelik gövde
- Çift kontak çıkışlı zamanlayıcılı ve yanıp sönen tipte havalandırma kontrol butonu



AVOX siva üstü kat kasedi hızlı ve kolay montaj seçeneği sunmaktadır. Ultra ince sivaüstü kat buton ve gösterge serisi 304L kalite satine paslanmaz çelik gövde. 430 kalite montaj sacı, polikarbonat gösterge camı, poliamit buton gövdesi, dotmatrix gösterge. Aşırı yük meşgul ve servis dışı ikonları.

- Kolay ve hızlı montaj
- Görme engelliler için kabarma figürlü uygun tasarım butonlar
- 304L kalite satine paslanmaz çelik gövde



- Dotmatrix gösterge
- Görme engellileri destekleyen ışıklı ve kabartmalı butonlar
- Çift yönlü haberleşme modülü sayesinde yüksek ses kalitesi

10

**GM**  
ASANSÖR



# REFERANSLAR



3E MÜHENDİSLİK



5E İNŞAAT GIDA TUR.



ACIBADEM SİGORTA



ADADAN İNŞAAT



AK MİMARİ İNŞ.



AKTEK YAPI



ALBULAK İNŞAAT



ALTINIŞIK İNŞ.



ALP MİMARLAR



ARCAD YAPI MÜH.



AREMPA



ARŞAN KAUCUK



AYATAŞ YAPI



AYDIN İNŞAAT



AYKAR İNŞAAT



BİLFEN OKULLARI



BR YAPI



MERT İNŞAAT



BÜYÜK UZUNLAR



GANTAŞ



ÇAĞ TEKNİK YAPI



ÇELEBİ İNŞAAT



CİHANGİR YAPI



ÇETİNLER İNŞAAT

# REFERANSLAR



DELTA İNŞ. MİMARLIK



UNITED GROUP



ARS YAPI



DENAR ŞİR. GRUBU



DORA YAPI



DENİZ GYO



DESEL YAPI PROJE



DUDULLU OSB



EKOLET



EKŞİOĞLU



EMKA



ENGİN POLAT İNŞ.



ERGÜN POLAT İNŞ.



ENSU YAPI İNŞ.



ENTAŞ



FABE GRUP



FİBERTON



FONSİYONEL YAPI



GÜLER GROUP



GÜMÜŞTAY



GÜNSAN TRAFİK



GÜNEŞ DİNAMİK



GNY&GÜNEY G.MENKUL



HH YAPI İNŞAAT

# REFERANSLAR



İNFORM



HUMAYAPI



MEKAN YAPI



**ARCYES İNŞAAT**  
Gayrimenkul ve Yatırım

ARCYES-İNŞAAT



KLAS İNŞAAT



İSMAİLOĞLU YAPI



KAR İNŞAAT

**Köseoğlu İnş.**

KÖSEOĞLU İNŞ.



KRN MİMARLIK



KURIS KULE



ÖZATALAR TEKNOLOJİ



MABCO



MESPLAST



ZİRAAT BANKASI



METAL YAPI KONUT



MAKİNA MÜH. ODASI



AYDUR İNŞAAT



ODAK İNCE YAPI SİS.



MUTLUSAN ELECTRIC



ODEABANK



BMY BAŞARAN MÜLK YAPI



OKYANUS HOLDİNG



ÖNALAN İNŞAAT



PİMTAŞ



444 0 942

www.gmasansor.com.tr

# REFERANSLAR



RC YAZICI İNŞAAT



ZEYREKLİ İNŞAAT



REIMCO



ŞAHİNLER İNŞAAT



ŞAKARER İNŞ.



SEFA İNŞAAT



SEMİ YAPI



SEVGİLİ YAPI



ŞİŞLİ BELEDİYESİ



SİLVANA



BERDA İNŞAAT



TAHİROĞLU İNŞAAT



TEMA CONSTRUCTION



TEMEL İNŞAAT



TBT İNŞAAT



TEK MERVE İNŞAAT



YALOVA KOLEJİ



TERRA



TORUN



TÜREV YAPI



UDİ YAPI



UMRAN YAPI



BİRÜNİ ÜNİVERSİTESİ



VALFSAN

# REFERANSLAR



Boğazköy Mimarlık  
Mühendislik, Taah. San. Tic. Ltd. Şti.



BOZAK YILDIZ



CK GROUP®  
CK GROUP İNŞ. SAN. VE TİC. LTD. ŞTİ.



yaşam çemberi  
ÇEMBERLİTAŞ  
İNŞAAT

BOĞAZKÖY MİMARLIK

BOZAK YILDIZ YAPI

CK GROUP

ÇEMBERLİTAŞ İNŞAAT



DG GROUP  
İNŞAAT



EKMAL  
YAPI



EMLAK KONUT  
GAYRİMENKUL YATIRIM ORTAKLIĞI A.Ş.  
T.C. ÇEVRE, ŞEHİRCİLİK VE İKLİM DEĞİŞİKLİĞİ BAKANLIĞI TOKİ İŞTİRAKİDİR



ENSAR İNŞAAT®

DG GROUP İNŞAAT

EKMAL YAPI

EMLAK KONUT

ENSAR İNŞAAT



ESKA  
KONUT

EVYAPGÜZELİNŞAAT



EVİM KADIKÖY



FAZLIOĞLU  
İNŞAAT GRUBU

ESKA KONUT

EVYAP GÜZEL İNŞAAT

EVİM KADIKÖY

FAZLIOĞLU İNŞAAT



FERYAPI



ATLANTIS  
GRUP

güneysu inşaat



HANLIYAPI

FERYAPI

ATLANTIS GRUP

GÜNEYSU İNŞAAT

HANLI YAPI



HARPÜT  
MÜHENDİSLİK MİMARLIK  
YAPI SAN. TİC. LTD. ŞTİ



INDUCTOTHERM  
GROUP TÜRKİYE



KÖSEOĞLU  
İNŞAAT SANAYİ VE TİCARET A.Ş.



LUCE  
MİMARLIK

HARPÜT MÜHENDİSLİK

INDUCTOTHERM GROUP

KÖSEOĞLU İNŞAAT

LUCE MİMARLIK



MATAYAPI  
25.yıl



MEDEL TIP



M<sup>3</sup> METREKÜP  
HOLDING



MÜLAZIMOĞLU

MATA YAPI

MEDEL TIP

METREKÜP HOLDING

MÜLAZIMOĞLU İNŞAAT



444 0 942

www.gmasansor.com.tr

# REFERANSLAR



NMK YAPI



NOVA YAPI



PRESTİJ COLD



REGNER



ROYAL YAPI



ÇAVUŞOĞLU İNŞAAT



SARICA İNŞAAT



SEGA YAPI



SERANOVA



SEVEN YATIRIM



SUER İNŞAAT



SURTAŞ KENT YAPI



TOKAL GRUP



ŞİŞİKLER İNŞAAT



USTAOĞLU İNŞAAT



UKİ YAPI



UZUNAL TASARIM YAPI



YENİ MİMARİ İNŞAAT



ZİRVE DOĞALTAŞ



ÖNDERGRUP İNŞAAT





444 0 942

[www.gmasansor.com.tr](http://www.gmasansor.com.tr)

## GM ASANSÖR

Sanayi Tic. Ltd. Şti.

### ADRES

Zümrütevler Mah. Atatürk Cad. Mimosacı Sk. No:42  
Maltepe - İSTANBUL

[info@gmasansor.com.tr](mailto:info@gmasansor.com.tr)

### FABRİKA

Tepeören, Millet Cd. No:16, 34959  
Tuzla/İstanbul

